

NOTE:
CORNICHE IS INTENDED TO BE INSTALLED USING ONLY THE APPROPRIATE COUNTERSINKING TOOL AND SCREW SYSTEM AS PROVIDED IN THE MELTON SAMPLE PACK. ALL BLOCKING, FASTENERS AND SEALANTS TO BE PROVIDED BY INSTALLER.

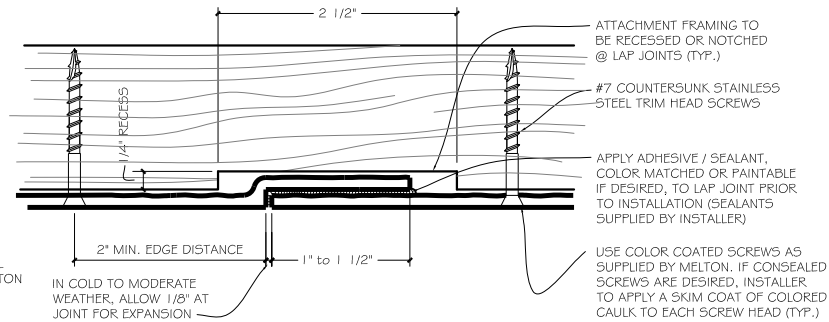

MC-48	Melton Classics Incorporated
SUBJECT	MC-48 CORNICHE DETAILS
PROJECT	STANDARD CORNICES
CONTRACTOR	MELTON CLASSICS INCORPORATED
DRAWN BY: JCH	DATE: 7/13/09