

NOTE:  
CORNICE IS INTENDED TO BE INSTALLED USING ONLY THE APPROPRIATE COUNTERSINKING TOOL AND SCREW SYSTEM AS PROVIDED IN THE MELTON SAMPLE PACK. ALL BLOCKING, FASTENERS AND SEALANTS TO BE PROVIDED BY INSTALLER.

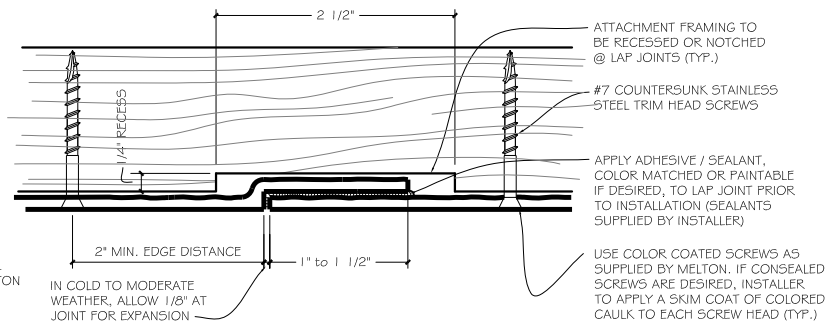

MC-47	<b>Melton Classics</b> Incorporated	
SUBJECT	MC-47 CORNICE DETAILS	
PROJECT	STANDARD CORNICES	
CONTRACTOR	MELTON CLASSICS INCORPORATED	
DRAWN BY: JCH		DATE: 7/13/09